

Spherical roller bearings, cylindrical and tapered bore

Principal dimensions			Basic load ratings		Speed ratings	Limiting speed	Designation
d	D	B	dynamic C	static C0	Reference speed		* SKF Explorer bearing
mm			kN		r/min		-
<b>400</b>	650	200	4864	7650	530	950	23180 CAK/W33 *

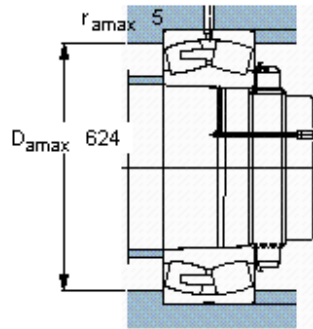
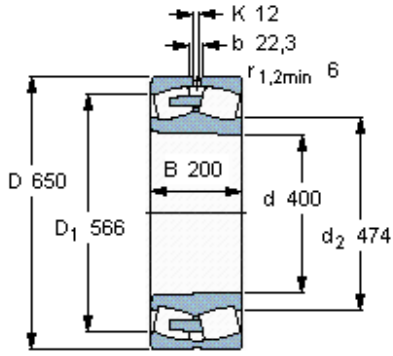

Tapered bore, taper  
1: 12

**Calculation factors**

- e 0,28
- $Y_1$  2,4
- $Y_2$  3,6
- $Y_0$  2,5